

RS

Diaphragm meter



Revision A - Edition 02/2023

**USE, MAINTENANCE
AND WARNING
MANUAL**

1 - INTRODUCTION

FOREWORD

All rights reserved. No part of this publication may be reproduced, distributed, translated into other languages or transmitted by any electronic or mechanical media, including photocopies, recording or any other storage and retrieval system, for any other purposes that are not exclusively the personal use of the buyer, without the express written permission of the Manufacturer.

The manufacturer is in no way responsible for the consequences of operations carried out in a manner not in accordance with the manual.

GENERAL REMARKS

All operating, maintenance instructions and recommendations described in this manual must be followed to in order to:

- obtain the best possible performance from the equipment;
- keep the equipment in efficient conditions.

Training the personnel in charge is essential in order to:

- use and service the equipment properly;
- correctly apply the safety alerts and recommended procedures.

NOTICE!

The images shown in this document indicate the type of product and may differ in detail.

Revision: A

1.1 - REVISION HISTORY

Revision index	Date	Revision contents
A	02/2023	First issue

Tab. 1.1.

INDEX

1 - INTRODUCTION	3
1.1 - REVISION HISTORY.....	5
2 - GENERAL INFORMATION	9
2.1 - MANUFACTURER IDENTIFICATION	9
2.2 - IDENTIFICATION OF THE PRODUCT	9
2.3 - REGULATORY FRAMEWORK.....	10
2.4 - WARRANTY	10
2.5 - ADDRESSEES, SUPPLY AND STORAGE OF THE INSTRUCTION MANUAL	11
2.6 - LANGUAGE	11
2.7 - SYMBOLS USED IN THE MANUAL.....	12
2.8 - APPLIED RATING PLATES	13
2.8.1 - DESCRIPTION OF THE NAMEPLATES.....	15
2.9 - GLOSSARY OF MEASUREMENT UNITS.....	16
2.10 - QUALIFIED PROFESSIONAL FIGURES	17
3 - SAFETY	19
3.1 - GENERAL SAFETY WARNINGS.....	19
3.1.1 - SAFETY INSTRUCTIONS FOR INSTALLATION IN HAZARDOUS AREA.....	20
3.2 - PERSONAL PROTECTIVE EQUIPMENT.....	21
3.3 - OBLIGATIONS AND PROHIBITIONS	22
3.4 - RESIDUAL RISKS	23
3.5 - SAFETY AND FRAUD PREVENTION	23
3.5.1 - SEALS	23
3.6 - SAFETY PICTOGRAMS	24
3.7 - RISK LEVEL	24
4 - DESCRIPTION AND OPERATION	25
4.1 - GENERAL DESCRIPTION	25
4.1.1 - ACQUISITION OF THE MEASURE.....	26
4.1.2 - USER INTERFACE.....	26
4.2 - INTENDED USE	27
4.2.1 - ENVISAGED USE	27
4.2.2 - REASONABLY FORESEEABLE MISUSE	27
4.3 - TECHNICAL DATA	28

5 - USER INTERFACE	29
5.1 - TOTALIZER DESCRIPTION	29
6 - TRANSPORT AND HANDLING	31
6.1 - SPECIFIC WARNINGS FOR TRANSPORT AND HANDLING	31
6.1.1 - PACKAGING AND FASTENERS USED FOR TRANSPORT	31
6.2 - PACKAGING CONTENT	33
6.3 - PHYSICAL CHARACTERISTICS RS / 2001 LA - STEEL	34
6.4 - PHYSICAL CHARACTERISTICS RS / 2001 LA - STEEL SINGLE CONNECTION	35
6.5 - PHYSICAL CHARACTERISTICS RS/2.4	36
6.6 - EQUIPMENT ANCHORING AND LIFTING METHOD	37
6.6.1 - FORKLIFT HANDLING METHOD	38
6.7 - PACKAGING REMOVAL	40
6.7.1 - PACKAGING DISPOSAL	40
7 - INSTALLATION	41
7.1 - GENERAL WARNINGS	41
7.2 - INSTALLATION PRE-REQUISITES	41
7.2.1 - ALLOWED ENVIRONMENTAL CONDITIONS	41
7.3 - CHECKS BEFORE INSTALLATION	42
7.4 - SPECIFIC SAFETY INSTRUCTIONS FOR THE INSTALLATION STEP	43
7.5 - INSTALLATION PROCEDURE	44
7.6 - TIGHTENING TORQUES	45
8 - MAINTENANCE AND FUNCTIONAL CHECKS	47
8.1 - GENERAL WARNINGS	47
9 - UNINSTALLATION AND DISPOSAL	49
9.1 - GENERAL SAFETY WARNINGS	49
9.2 - QUALIFICATION OF THE OPERATORS IN CHARGE	49
9.3 - UNINSTALLATION	49
9.4 - INFORMATION REQUIRED IN CASE OF NEW INSTALLATION	50
9.5 - INFORMATION REQUIRED IN CASE OF RE-INSTALLATION	50
9.6 - DISPOSAL INFORMATION	50

2 - GENERAL INFORMATION

2.1 - MANUFACTURER IDENTIFICATION

Manufacturer	PIETRO FIORENTINI S.P.A.
Address	Via Enrico Fermi, 8/10 36057 Arcugnano (VI) - ITALY Tel. +39 0444 968511 Fax +39 0444 960468 www.fiorentini.com sales@fiorentini.com

Tab. 2.2.

NOTICE!

For any problem encountered on the installed equipment, contact the distributor of the reference gas mains.

2.2 - IDENTIFICATION OF THE PRODUCT

Equipment	DIAPHRAGM METER
Series	RS
Available models	<ul style="list-style-type: none"> • RS/2001 LA • RS/2,4

Tab. 2.3.

2.3 - REGULATORY FRAMEWORK

PIETRO FIORENTINI S.P.A. with registered office in Arcugnano (Italy) - Via E. Fermi, 8/10, declares that the equipment of the RS series described in this manual is designed, manufactured, tested and checked in compliance with:

- the requirements of Directive 2014/32/EU 'MID';
- the product standard for 'Diaphragm gas meters' EN 1359;
- the OIML international recommendations R 137-1 & 2.

NOTICE!

For specific type approvals, see the appropriate section on the Manufacturer's website: <https://www.fior-entini.com>

NOTICE!

The declaration of conformity in its original version is delivered together with the equipment.

2.4 - WARRANTY

PIETRO FIORENTINI S.P.A. guarantees that the equipment was manufactured using the best materials, with high quality workmanship, and complies with the quality requirements, specifications and performance set out in the order.

The warranty shall be considered null and void and PIETRO FIORENTINI S.P.A. shall not be liable for any damage and/or malfunctions:

- due to any acts or omissions of the purchaser or end-user, or any of their carriers, employees, agents, or any third party or entity;
- in the event that the purchaser, or a third party, makes changes to the equipment supplied by PIETRO FIORENTINI S.P.A. without the prior written approval of the latter;
- in the event of failure by the purchaser to comply with the instructions contained in this manual, as provided by PIETRO FIORENTINI S.P.A.

NOTICE!

The warranty conditions are specified in the commercial contract.

2.5 - ADDRESSEES, SUPPLY AND STORAGE OF THE INSTRUCTION MANUAL

The instruction manual is intended for qualified technicians responsible for operating and managing the equipment throughout its service life.

It contains the necessary information to properly use the equipment and keep its functional and qualitative characteristics unchanged over time. All information and warnings for safe, correct use are also provided.

The manual, as well as the declaration of conformity and/or test certificate, is an integral part of the equipment and must always accompany it whenever it is moved or resold. It is the responsibility of the qualified professionals (see paragraph 2.10) to use and manage the equipment.

WARNING!

Removing, rewriting or modifying the pages of the manual and their contents is not allowed.

PIETRO FIORENTINI S.p.A. shall not be held liable for any damage to people, animals and property caused by failure to adhere to the warnings and operating procedures described in this manual.

2.6 - LANGUAGE

The original instruction manual was drawn up in Italian.

Any translations into additional languages are to be made from the original instruction manual.

HAZARD!

The translations into other languages cannot be fully verified. If any inconsistency is found, please refer to the original instruction manual.



If inconsistencies are found or the text does not make sense:

- stop any actions;
- immediately contact PIETRO FIORENTINI S.p.A. at the addresses specified in paragraph 2.1 (“Identification of the manufacturer”).

WARNING!

PIETRO FIORENTINI S.p.A. shall be held liable for the information provided in the original manual only.

2.7 - SYMBOLS USED IN THE MANUAL

Symbol	Definition
	Symbol used to identify important warnings for the safety of the operator and/or equipment.
	Symbol used to identify information of particular importance in the instruction manual. The information may also concern the safety of the personnel involved in using the equipment.
	Obligation to consult the instruction manual/booklet. Indicates a requirement for the personnel to refer to (and understand) the operating and warning instructions of the machine before working with or on it.

Tab. 2.4.

HAZARD!

Alerts to a hazard with a high level of risk, an imminent hazardous situation which, if not prevented, will result in death or severe damage.

WARNING!

Alerts to a hazard with a medium level of risk, a potentially hazardous situation which, if not prevented, may result in death or severe damage.

ATTENTION!

Alerts to a hazard with a low level of risk, a potentially hazardous situation which, if not prevented, could result in minor or moderate damage.

NOTICE!

Alerts to specific warnings, directions or notes of particular concern, that are not related to physical injury, as well as practices for which physical injury is not likely to occur.

2.8 - APPLIED RATING PLATES

WARNING!

Removing nameplates and/or replacing them with other plates is strictly not allowed.
Should the plates be unintentionally damaged or removed, the customer must notify
PIETRO FIORENTINI S.p.A.

NOTICE!

Variants of the metrological covers can be provided on demand for:

- compliance with local regulations;
- other specific requests.

The equipment and its accessories are provided with nameplates (from Id.1 to Id.5).

The nameplates specify identification details of the equipment and its accessories to be mentioned in case of need to PIETRO FIORENTINI S.p.A.

List of identification plates applied to metrological covers:

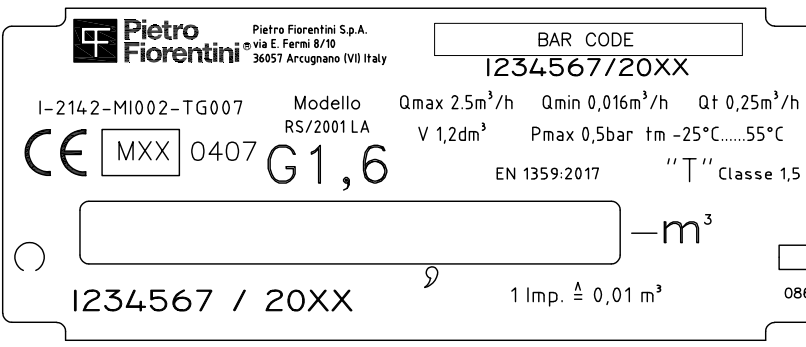
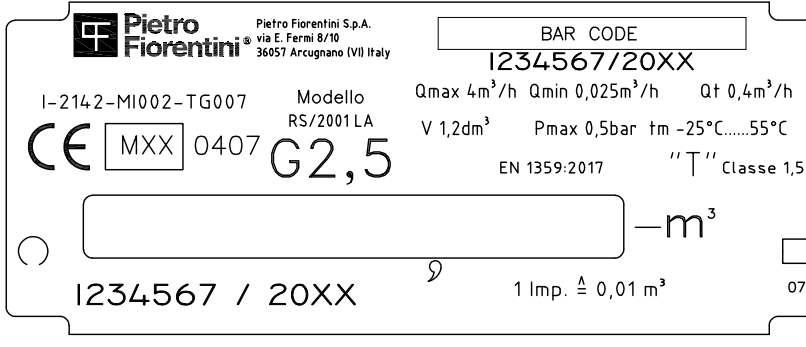
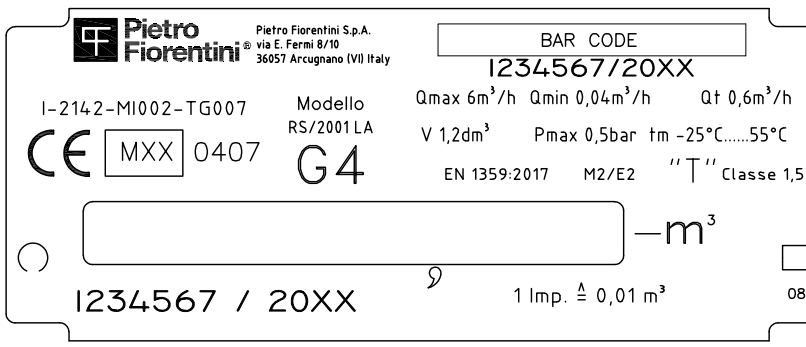
Id.	Reference model	Identification plate drawing
1	RS 2001 / LA G1,6	 <p> Pietro Fiorentini Pietro Fiorentini S.p.A. <small>via E. Fermi 8/10 36057 Arcugnano (VI) Italy</small> </p> <p> I-2142-MI002-TG007 Modello RS/2001 LA G1,6 </p> <p> CE MXX 0407 G1,6 </p> <p> Qmax 2.5m³/h Qmin 0,016m³/h Qt 0,25m³/h V 1,2dm³ Pmax 0,5bar tm -25°C.....55°C EN 1359:2017 "T" Classe 1,5 </p> <p> 1234567 / 20XX 1 Imp. Δ 0,01 m³ 0860 </p>
2	RS 2001 / LA G2,5	 <p> Pietro Fiorentini Pietro Fiorentini S.p.A. <small>via E. Fermi 8/10 36057 Arcugnano (VI) Italy</small> </p> <p> I-2142-MI002-TG007 Modello RS/2001 LA G2,5 </p> <p> CE MXX 0407 G2,5 </p> <p> Qmax 4m³/h Qmin 0,025m³/h Qt 0,4m³/h V 1,2dm³ Pmax 0,5bar tm -25°C.....55°C EN 1359:2017 "T" Classe 1,5 </p> <p> 1234567 / 20XX 1 Imp. Δ 0,01 m³ 0792 </p>
3	RS 2001 / LA G4	 <p> Pietro Fiorentini Pietro Fiorentini S.p.A. <small>via E. Fermi 8/10 36057 Arcugnano (VI) Italy</small> </p> <p> I-2142-MI002-TG007 Modello RS/2001 LA G4 </p> <p> CE MXX 0407 G4 </p> <p> Qmax 6m³/h Qmin 0,04m³/h Qt 0,6m³/h V 1,2dm³ Pmax 0,5bar tm -25°C.....55°C EN 1359:2017 M2/E2 "T" Classe 1,5 </p> <p> 1234567 / 20XX 1 Imp. Δ 0,01 m³ 0829 </p>

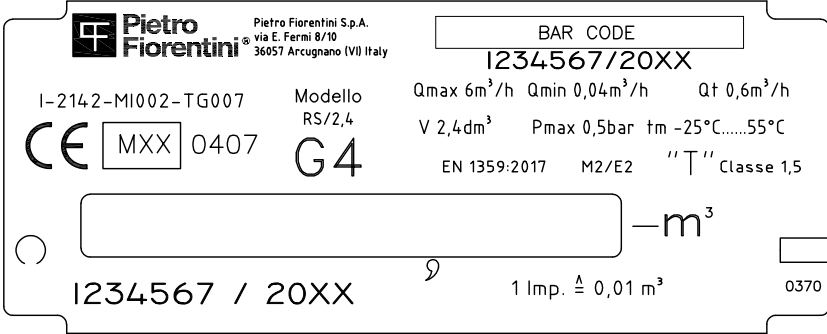
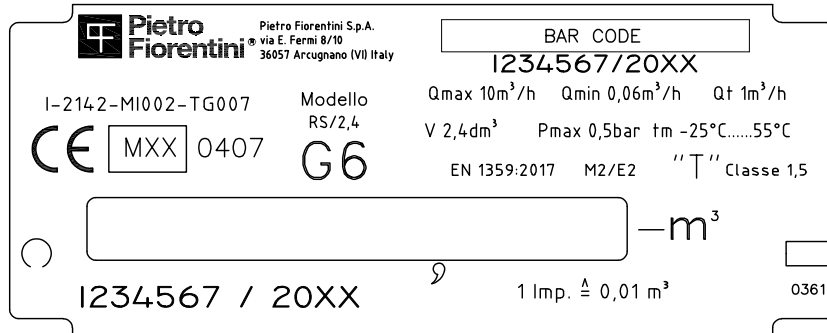
Id.	Reference model	Identification plate drawing
4	RS/2,4 G4	 <p> Pietro Fiorentini Pietro Fiorentini S.p.A. via E. Fermi 8/10 36057 Arcugnano (VI) Italy </p> <p> I-2142-MI002-TG007 Modello RS/2,4 CE MXX 0407 G4 </p> <p> Q_{max} 6m³/h Q_{min} 0,04m³/h Q_t 0,6m³/h V 2,4dm³ P_{max} 0,5bar t_m -25°C.....55°C EN 1359:2017 M2/E2 "T" Classe 1,5 </p> <p> 1234567 / 20XX 1 Imp. Δ 0,01 m³ 0370 </p>
5	RS/2,4 G6	 <p> Pietro Fiorentini Pietro Fiorentini S.p.A. via E. Fermi 8/10 36057 Arcugnano (VI) Italy </p> <p> I-2142-MI002-TG007 Modello RS/2,4 CE MXX 0407 G6 </p> <p> Q_{max} 10m³/h Q_{min} 0,06m³/h Q_t 1m³/h V 2,4dm³ P_{max} 0,5bar t_m -25°C.....55°C EN 1359:2017 M2/E2 "T" Classe 1,5 </p> <p> 1234567 / 20XX 1 Imp. Δ 0,01 m³ 0361 </p>

Tab. 2.5.

2.8.1 - DESCRIPTION OF THE NAMEPLATES

The following information, described in Tab.2.6, is shown on the nameplate:

Pos.	Description
1	Manufacturer's Address
2	Manufacturer's Logo
3	"MID" Directive marking
4	Internal serial number
5	Year of manufacture
6	Model type
7	Calibre value
8	Pulse equivalence /m ³
9	Serial Number
10	Reference standard for domestic diaphragm gas meters, Manufacturer's calibrations, approval levels and meter reference class
11	Unit of measurement

Tab. 2.6.

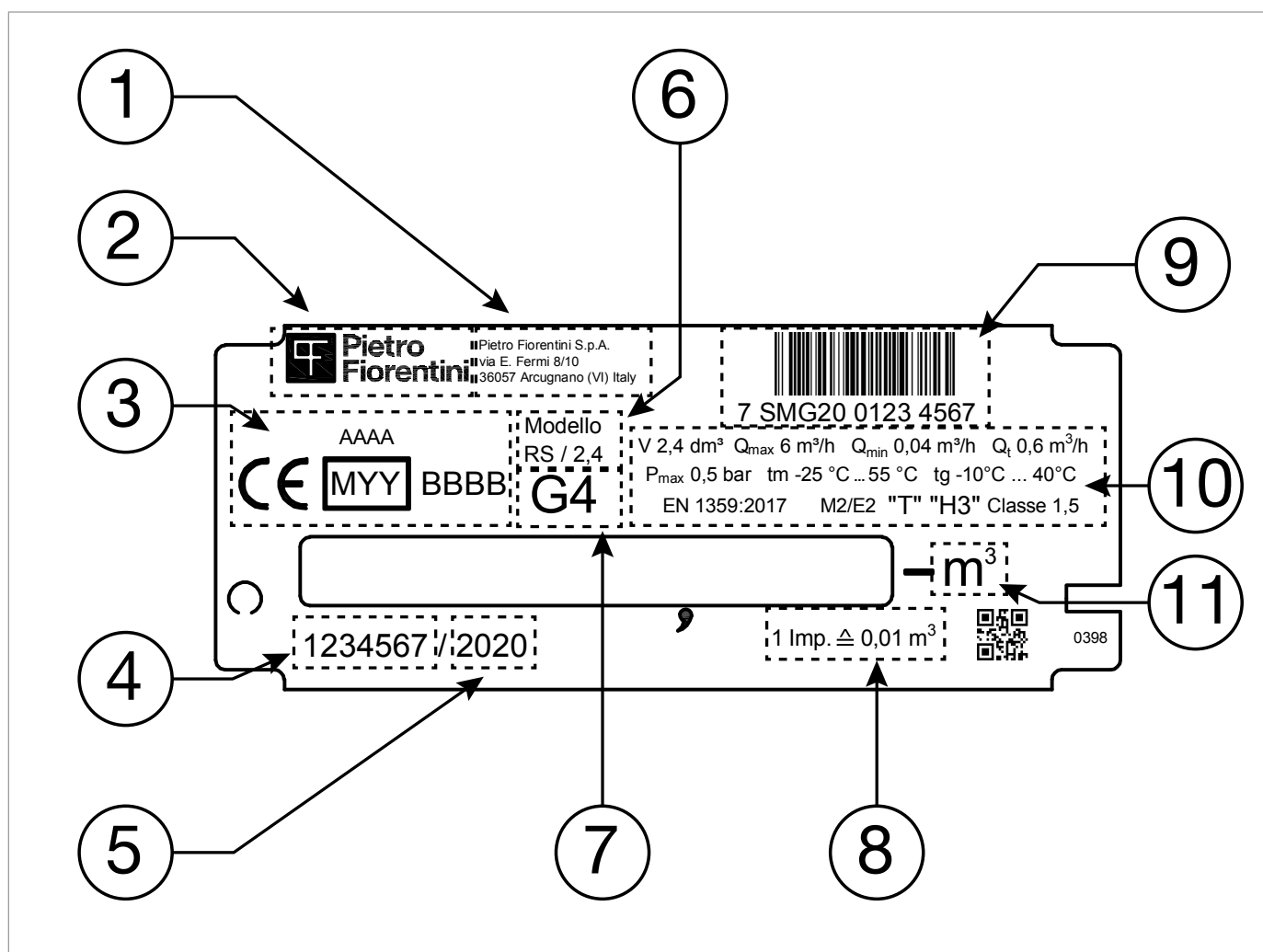

Fig. 2.1. Description of the nameplates

2.9 - GLOSSARY OF MEASUREMENT UNITS

Type of measurement	Unit of measurement	Description
Consumption and Volumetric flow rate	Sm ³ /h	Standard cubic metres per hour
	Sm ³	Standard cubic metres
	m ³ /h	Cubic metres per hour
	m ³	Cubic metres
Pressure	bar	Bar
	”wc	Water column inch
	Pa	Pascal
Temperature	°C	Degree centigrade
	K	Kelvin
Tightening torque	Nm	Newton metre

Tab. 2.7.

2.10 - QUALIFIED PROFESSIONAL FIGURES

Qualified operators in charge of using and managing the equipment throughout its technical service life to be used as indicated:

Professional figure	Definition
<p style="text-align: center;">Installer</p>	<p>Qualified operator able to:</p> <ul style="list-style-type: none"> • handle materials and equipment. • carry out all the operations necessary to properly install the equipment; • perform all the operations necessary to safely operate the equipment and system; • be able to perform all the operations necessary to uninstall and subsequently dispose of the equipment in compliance with the regulations in force in the country of installation.
<p style="text-align: center;">Specialised technician/ Maintenance technician</p>	<p>Trained and authorised technician on the management and use of the equipment, who must:</p> <ul style="list-style-type: none"> • be able to perform all operations required for the proper functioning of the equipment and the system, and for their safety and that of any third parties present; • perform maintenance on all parts of the equipment subject to maintenance (board and batteries); • access all device parts for visual inspection, checking equipment status, making adjustments and calibrations; • have proven experience in properly using the equipment similar to that described in this manual, and be trained, informed and instructed in this regard.

Tab. 2.8.

3 - SAFETY

3.1 - GENERAL SAFETY WARNINGS

WARNING!

The equipment described in this manual is normally installed in systems which transport flammable gases (for example natural gas).

WARNING!

If the gas used is a combustible gas, the installation area of the equipment is defined as a “danger zone” as there are residual risks that potentially explosive atmospheres may be generated.

In “danger zones” and in close proximity thereto:

- there must not be any effective sources of ignition;
- no smoking.

WARNING!

- It is strictly forbidden to repair or make any modifications to the equipment.
- For information and warnings regarding replacing batteries, refer to chapter 9 in this manual.

ATTENTION!

Authorised operators must not carry out operations or services on their own initiative that do not fall within their competence.

Never operate the equipment:

- while under the influence of intoxicating substances such as alcohol;
- if you are using drugs that may slow reaction times.

NOTICE!

The employer must train and inform operators on how to behave during operations and on the equipment to be used.

Before installation, commissioning or maintenance, operators must:

- take note of the safety regulations applicable to the place of installation they are working in;
- obtain the necessary permits to operate when required;
- wear the personal protective equipment required by the procedures described in this instruction manual;
- ensure that the area that they are operating in is equipped with the required collective protections and the necessary safety information.

3.1.1 - SAFETY INSTRUCTIONS FOR INSTALLATION IN HAZARDOUS AREA

This device must be installed and operated in compliance with the provisions and regulations in force.

NOTICE!

PIETRO FIORENTINI S.p.A. shall not be liable for damage resulting from failure to comply with the instructions and from misuse.

Safety warnings

All operations on the device must be performed by qualified personnel.

Transformation and spare parts

Any technical changes are forbidden. Use only original spare parts intended by PIETRO FIORENTINI S.p.A.

Transport

As a rule, RS must be transported in an upright position and inside the original packaging box provided by PIETRO FIORENTINI S.p.A.

Upon receipt of the device, examine the supplied material.

Immediately report any shipping damage.

Storage

RSAs a rule, it should be stored upright in a dry place at room temperature.

WARNING!



- **The arrow on the top of the device indicates the direction of the gas flow.**
- **Install the device in a compartment that meets the provisions in force on safety, away from any possible damage of mechanical origin, away from sources of heat or naked flames, in a dry place and protected from external agents.**
- **Install the device with the indicator device in a horizontal position, not in contact with walls and raised from the floor.**
- **During installation, avoid mechanical stress to the inlet and outlet connections.**
- **The optional shut-off valve, located in the system upstream of the device, must be opened in a gradual manner in order to allow the gas to flow evenly, without violent shocks that would damage the internal components.**
- **It is strictly forbidden to repair or make any modifications to the device.**
- **The installation, removal, and any operations must be performed by qualified personnel, in compliance with the provisions in force concerning safety.**

3.2 - PERSONAL PROTECTIVE EQUIPMENT

The following table shows the Personal Protective Equipment (PPE) and its description; an obligation is associated with each symbol.

Personal protective equipment means any equipment intended to be worn by the worker in order to protect them against one or several risks that are likely to threaten their safety or health during work.

For the operators in charge, depending on the type of work requested, the most appropriate PPE from those reported in Tab.3.9 must be used:

Symbol	Meaning
	Obligation to use safety or insulated gloves. Indicates a requirement for the personnel to use safety or insulated gloves.
	Obligation to use safety goggles. Indicates a requirement for personnel to use protective goggles for eye protection.
	Obligation to use safety shoes. Indicates a requirement for the personnel to use accident-prevention safety shoes.
	Obligation to use noise protection equipment. Indicates a requirement for the personnel to use ear muffs or ear plugs to protect their hearing.
	Obligation to wear protective clothing. Indicates a requirement for the personnel to wear specific protective clothing.
	Obligation to use a protective mask. Indicates a requirement for the personnel to use respiratory masks in the event of a chemical risk.
	Obligation to use a protective helmet. Indicates a requirement for the personnel to use protective helmets.
	Obligation to wear high visibility vests. Indicates a requirement for the personnel to use high visibility vests.

Tab. 3.9.

WARNING!

Each licensed operator is obliged to:

- **take care of his/her own health and safety and that of other people in the workplace who are affected by his/her actions or omissions, in accordance with the training, instructions and equipment provided by the employer;**
- **appropriately use the PPE made available;**
- **immediately report to the employer, the manager or the person in charge of the deficiencies of the means and devices as well as any possible dangerous conditions of which they become aware.**

3.3 - OBLIGATIONS AND PROHIBITIONS

The following is a list of obligations and prohibitions to be observed for the safety of the operator:

It is mandatory to:

- carefully read and understand the use, maintenance and warning manual;
- before installing the equipment, strictly refer to the details specified on the nameplates and in the manual;
- avoid knocks and violent impact that could damage the equipment.

It is forbidden to:

- operate in various capacities on the equipment without the PPE indicated in the work procedures described in this manual;
- operate in the presence of open flames or bring open flames close to the work area;
- smoke near the equipment or while working on it;
- use the equipment with parameters other than those indicated on the nameplate;
- use the equipment with gas units other than those indicated on the meter nameplate;
- use the equipment outside the operating temperature range declared on the identification plate and indicated in this manual;
- install or use the equipment in environments other than those specified in this manual.

3.4 - RESIDUAL RISKS

The equipment does not present residual risks for the operator related to its normal operation.

3.5 - SAFETY AND FRAUD PREVENTION

3.5.1 - SEALS

On the equipment PIETRO FIORENTINI S.p.A. model RS there are the following seals described in Tab.3.10:

Symbol	Type	Description
	Metrological seal	They point out that access to the equipment is not possible without the removal of the seal and the resulting permanent and evident damage to the equipment.

Tab. 3.10.

WARNING!

It is absolutely forbidden to remove or alter the seals on the equipment.

3.6 - SAFETY PICTOGRAMS

The safety pictograms described in Tab.3.11 may be shown on the equipment and/or packaging PIETRO FIORENTINI S.p.A.:

Symbol	Definition
	Symbol used to identify a GENERIC HAZARD.

Tab. 3.11.

WARNING!

It is absolutely forbidden to remove or alter the safety pictograms on the equipment or the packaging.

3.7 - RISK LEVEL

For the value of the noise generated by the equipment and further information, contact PIETRO FIORENTINI S.p.A.

ATTENTION!

The obligation to use earmuffs or ear plugs to protect the hearing of qualified professional figures (reference paragraph 2.10) remains in the event that the noise in the installation environment of the equipment (depending on specific operating conditions) exceeds the value of 85 dBA.

4 - DESCRIPTION AND OPERATION

4.1 - GENERAL DESCRIPTION

The apparatus RS is a volumetric meter used at the end points of gas distribution networks equipped with a diaphragm measuring system to measure the volume of gas transited.

The equipment RS is a measuring apparatus with accuracy class 1.5 as defined in Directive 2014/32/EU (MID).

The main elements of the equipment are (see Fig. 4.2.):

Pos.	Description	Pos.	Description
1	Data dial	4	Inlet connection
2	Totaliser	5	Outlet connection
3	Metal enclosure	6	Metrological seals

Tab. 4.12.

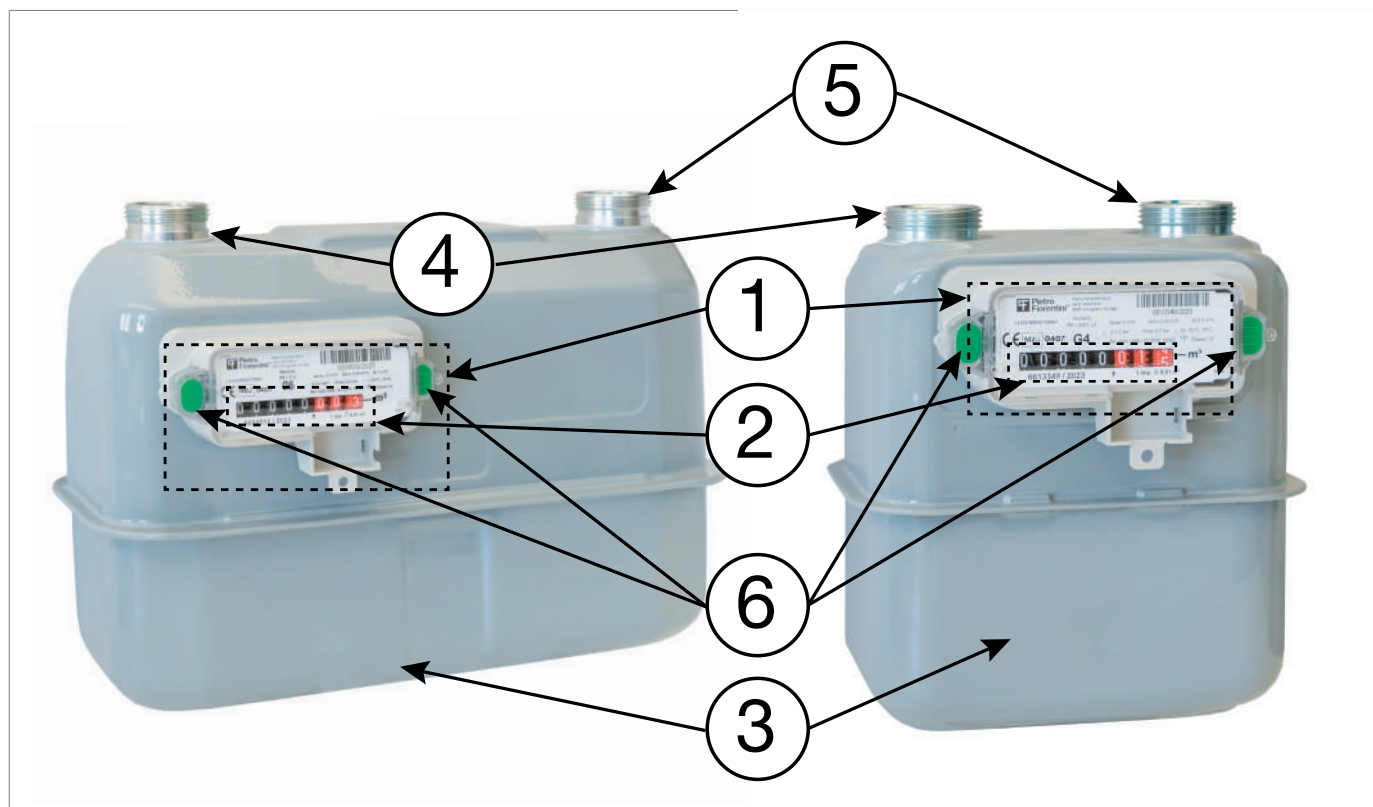

Fig. 4.2. General description RS

4.1.1 - ACQUISITION OF THE MEASURE

The gas volume measurement (flow rate) is carried out continuously by means of the mechanical system consisting of two measuring chambers (of known volume) with deformable diaphragms, which expand and contract alternately. This movement, induced by the pressure difference between the inlet and outlet passages, is transmitted to a pin that makes a complete turn at every cyclic volume of gas passing through.

The movement of the pin causes the mechanical totaliser to rotate.

4.1.2 - USER INTERFACE

 **NOTICE!**

Refer to chapter 5 in this manual for all information on the user interface.

4.2 - INTENDED USE

4.2.1 - ENVISAGED USE

The RS meter is intended for:

Operation	Permitted	Not Permitted	Work environment
Measurement of gas volume	<ul style="list-style-type: none"> Methane gas, town gas, propane and butane. Gases from the first to the third family (UNI EN 437). Mixtures of Natural Gas and Hydrogen (with the hydrogen component not exceeding 20%). 	Any other type of gas other than permitted.	Application in gas distribution networks final redelivery points for use: <ul style="list-style-type: none"> residential; commercial.

Tab. 4.13.

The equipment referred to was designed to be used exclusively within the limits specified on the nameplate and according to the instructions and limits of use specified in this manual.

Safe work parameters are:

- use within the limits stated on the nameplate and in this manual;
- compliance with the user manual procedures;
- do not tamper with and/or bypass the safety devices.

4.2.2 - REASONABLY FORESEEABLE MISUSE

Incorrect and reasonably foreseeable misuse means the use of the equipment in a way not foreseen in the phase but which can result from result predictable human behaviour:

- using the equipment in a manner other than that referred to under “**Intended use**”.
- instinctive reaction of an operator in the event of a malfunction, accident or breakdown while using the equipment;
- behaviour resulting from carelessness;
- behaviour resulting from the use of the equipment by unauthorised and unsuitable people;

Any use of the equipment other than the intended use must be previously approved in writing by PIETRO FIORENTINI S.p.A. If no written approval is provided, use shall be considered “**improper**”.

In the event of “improper use”, PIETRO FIORENTINI S.p.A. shall not be held liable for any damage caused to people or property, and any type of warranty on the equipment shall be deemed void.

4.3 - TECHNICAL DATA

General features	
Body	Galvanised, deep-drawn and powder-coated steel sheet
Threaded fitting/Connections	1" 1/4 ISO 228 Other dimensions on request
Resistance to high temperatures "T"	Approved for high temperatures
Maximum working pressure	0.5 bar
Operative temperature range	from -25 °C to +55 °C
Gas temperature range	from -25 °C to +55 °C
Pressure drop at maximum capacity	≤ 2 mbar

Tab. 4.14.

5 - USER INTERFACE

5.1 - TOTALIZER DESCRIPTION

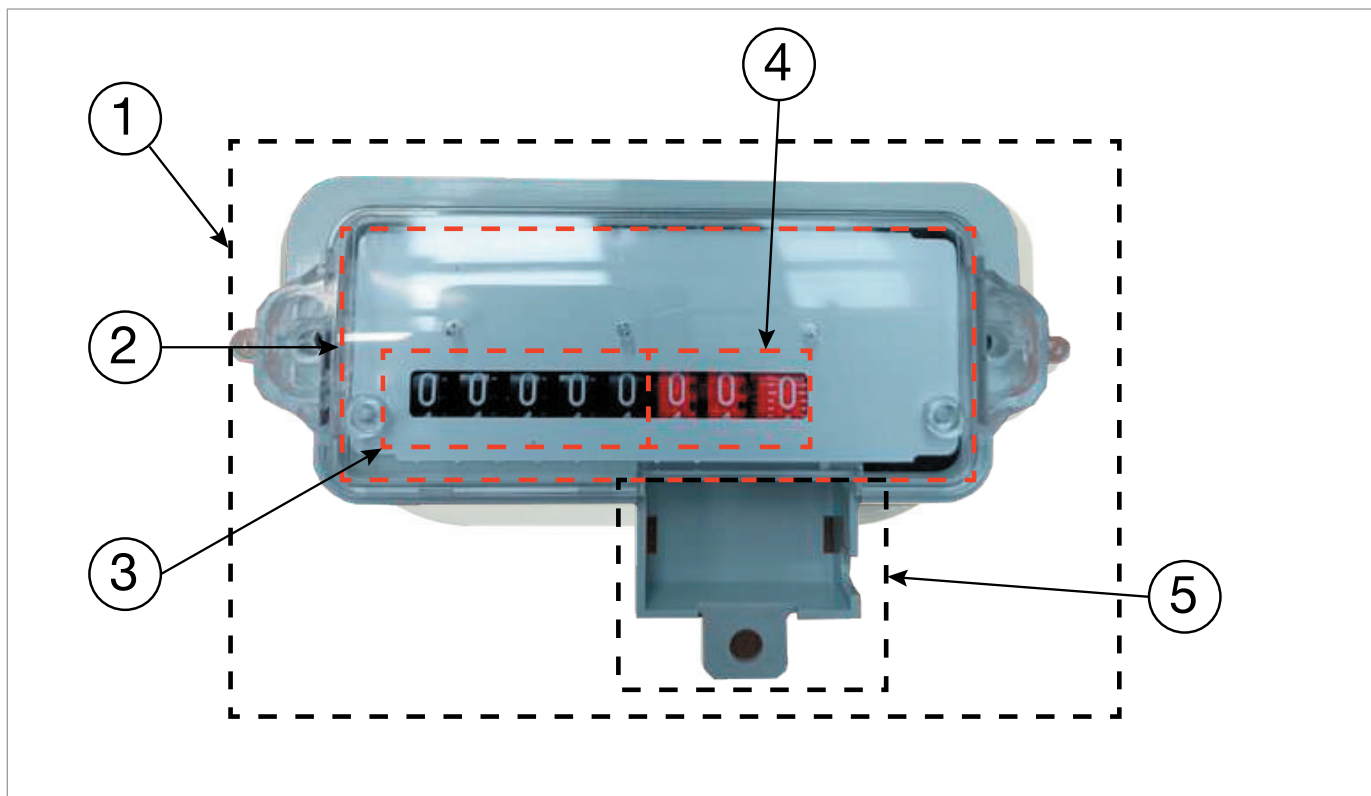

Fig. 5.3. Totaliser

Tab. 5.15. the main sectors on the totaliser are described:

Pos.	Name	Description
1	Totaliser box	
2	Transparent front panel	
3	Black intermediate roller	
4	Red intermediate roller	
5	Pulse emitter slot	

Tab. 5.15.

6 - TRANSPORT AND HANDLING

6.1 - SPECIFIC WARNINGS FOR TRANSPORT AND HANDLING

NOTICE!

Transport and handling must be carried out in compliance with the regulations in force in the country of installation by personnel who are:

- qualified (specially trained);
- who are familiar with accident prevention and workplace safety regulations;
- authorised to use lifting equipment.

Transport and handling

Operator qualification	<ul style="list-style-type: none"> • Installer.
PPE required	 <p>WARNING!</p> <p>The PPE listed in this table is related to the risk associated with the equipment. For the PPE required to protect against risks associated with the workplace, installation or operating conditions, please refer to:</p> <ul style="list-style-type: none"> • the regulations in force in the country of installation; • <u>any information provided by the Safety Manager at the installation facility.</u>
Weights and dimensions of the equipment	For dimensions and weights please refer to sections 6.3, 6.4 and 6.5.

Tab. 6.16.

6.1.1 - PACKAGING AND FASTENERS USED FOR TRANSPORT

The transport packaging is designed and manufactured to avoid damage during normal transport, storage and handling. The equipment must be kept in the packaging until installation.

Upon receiving the equipment, please:

- make sure that no part has been damaged during transport and/or handling;
- immediately report any damage found to PIETRO FIORENTINI S.p.A..

NOTICE!

PIETRO FIORENTINI S.p.A. shall not be liable for any damage to people or property caused by accidents due to failure to comply with the instructions provided in this manual.

Tab. 6.17. describes the types of packaging used:

Ref.	Type of packaging	Image
A	Single cardboard box - RS / 2001 LA	

Ref.	Type of packaging	Image
B	Single cardboard box - RS / 2.4	

Tab. 6.17.

6.2 - PACKAGING CONTENT

 **NOTICE!**

The EC declaration of conformity is attached to the transport document of the equipment.

The packaging contains:

Description of content

RS gas meter including:

- 2 plugs for the protection of the connection fittings.
- 2 gaskets for mounting.

 **NOTICE!**

It is recommended to keep the protective caps in place until the equipment is assembled.

Tab. 6.18.

 **NOTICE!**

The use, maintenance and warning manual can be downloaded from the Manufacturer's website: <https://www.fiorentini.com>

6.3 - PHYSICAL CHARACTERISTICS RS / 2001 LA - STEEL

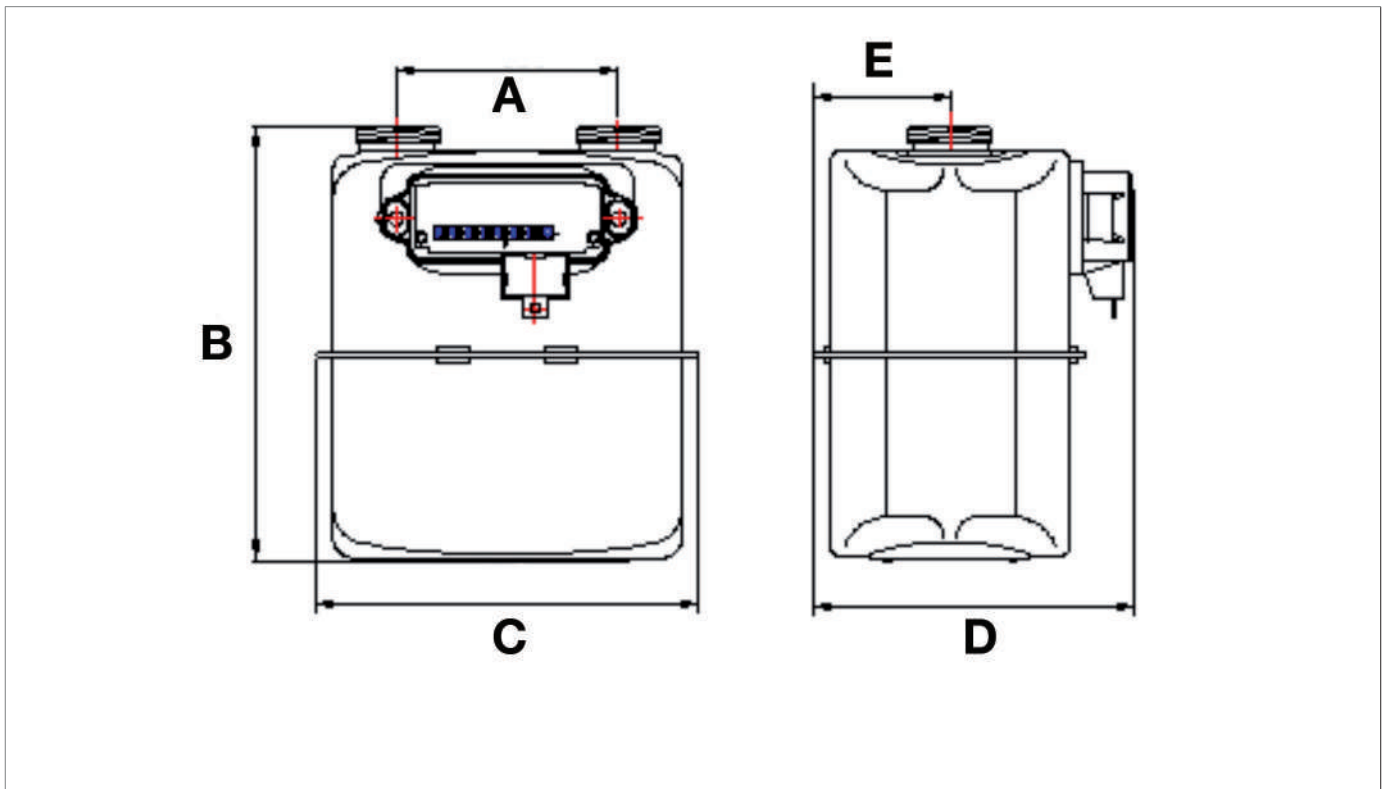

Fig. 6.4. Dimensions RS/2001 LA

Overall dimensions	
Ref.	Dimensions [mm]
A	110
B	210
C	190
D	162
E	68

Tab. 6.19.

Weights [kg]	
Without packaging	
Including packaging	

Tab. 6.20.

6.4 - PHYSICAL CHARACTERISTICS RS / 2001 LA - STEEL SINGLE CONNECTION

Fig. 6.5. Dimensions RS/2001 LA

Overall dimensions	
Ref.	Dimensions [mm]
B	223
C	190
D	162
E	68

Tab. 6.21.

Weights [kg]	
Without packaging	
Including packaging	

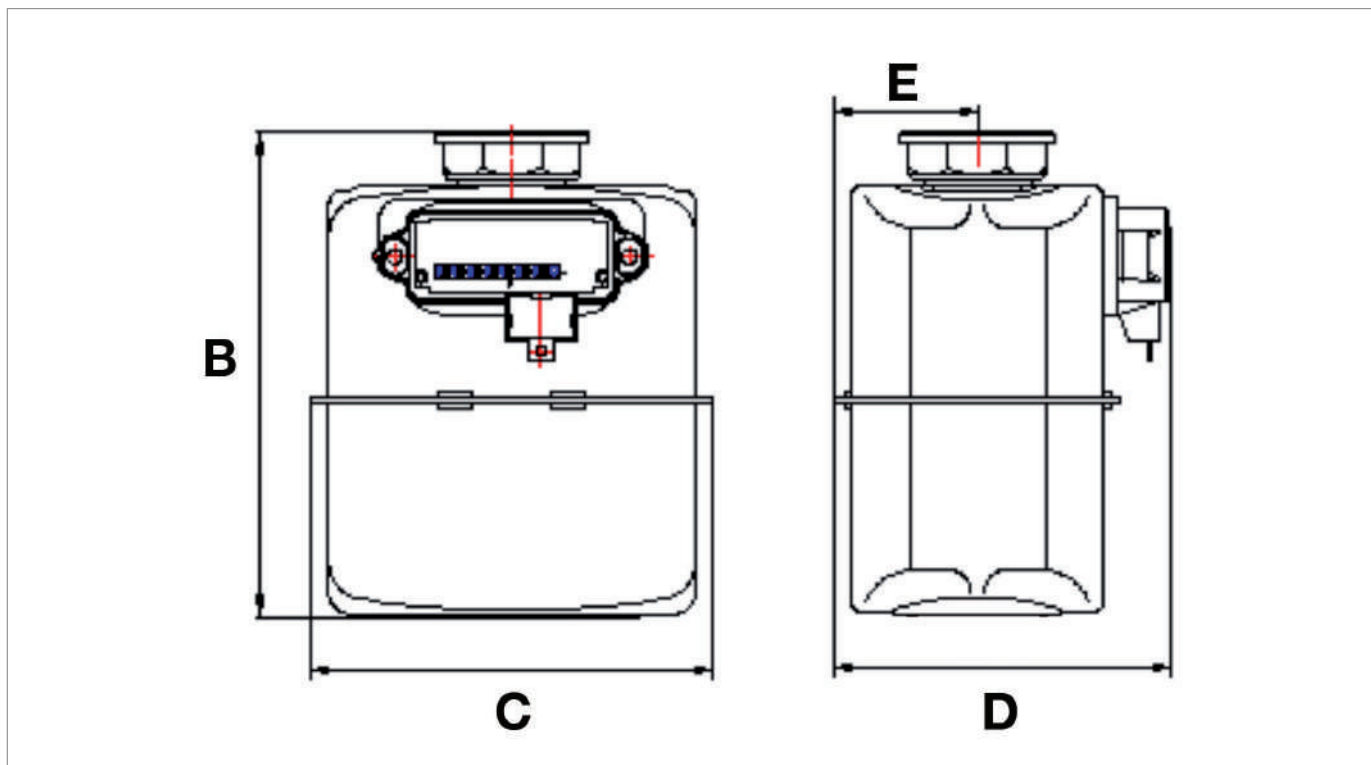
Tab. 6.22.

6.5 - PHYSICAL CHARACTERISTICS RS/2.4

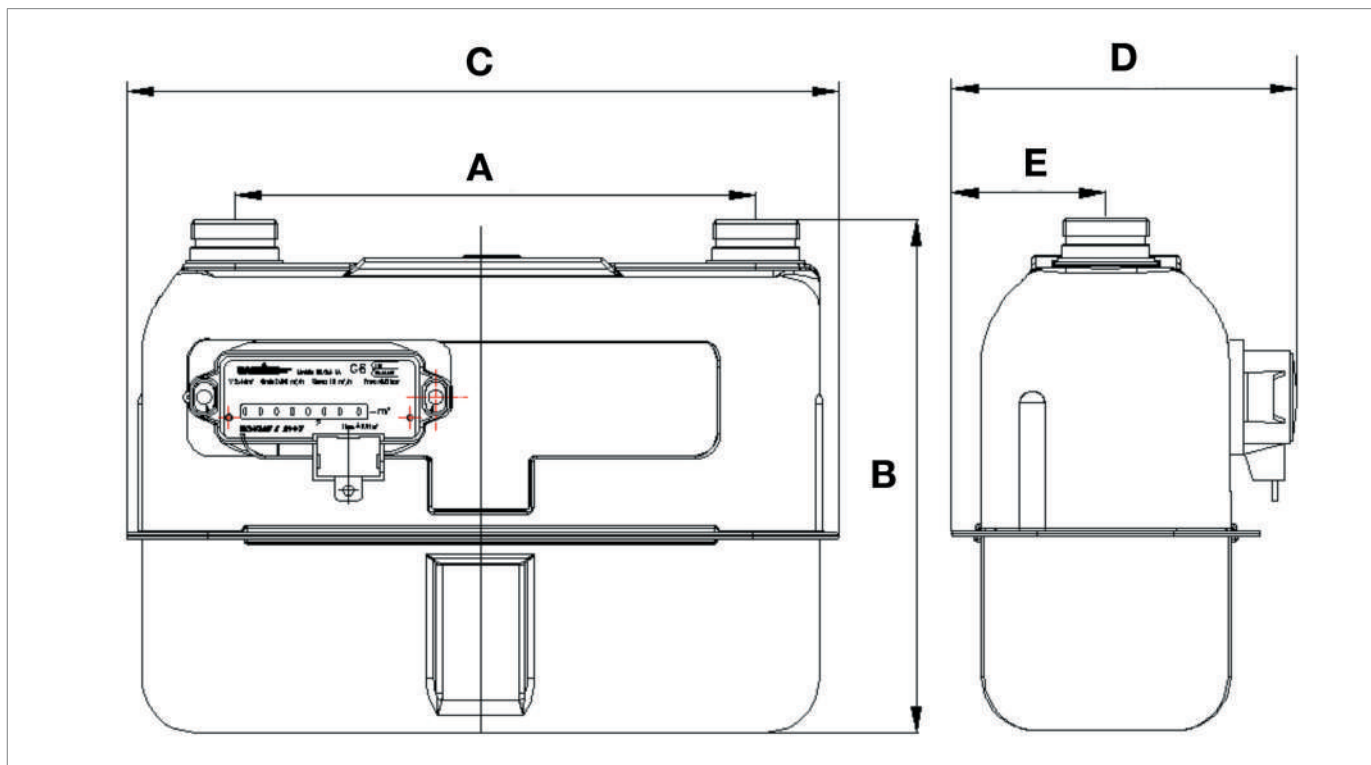

Fig. 6.6. Dimensions RS/2.4

Overall dimensions	
Ref.	Dimensions [mm]
A	250
B	246
C	341,5
D	168,5
E	74

Tab. 6.23.

Weights [kg]	
Without packaging	
Including packaging	

Tab. 6.24.

6.6 - EQUIPMENT ANCHORING AND LIFTING METHOD

HAZARD!

Using lifting equipment (if necessary) for unloading, carrying and handling packages is reserved only for skilled operators who have been properly trained (and are appropriately qualified if required by the regulations in force in the country of installation) and are familiar with:

- accident prevention rules;
- workplace safety provisions;
- lifting equipment features and limits.

HAZARD!

Before handling a load, make sure that its weight does not exceed the load capacity of the lifting equipment (and any other lifting tools) specified on the specific plate.

ATTENTION!

Before moving the equipment:

- remove any movable or hanging component or firmly secure it to the load;
- protect fragile equipment;
- check that the load is stable;
- make sure to have perfect visibility along the route.

6.6.1 - FORKLIFT HANDLING METHOD

HAZARD!

It is forbidden to:

- Do not transit under suspended loads;
- Do not move the load over the personnel operating in the site/plant area.

WARNING!



The following is not allowed on forklifts:

- carrying passengers;
- lifting people.

WARNING!

During all handling operations, pay close attention to avoid impact or vibrations of the equipment batteries.

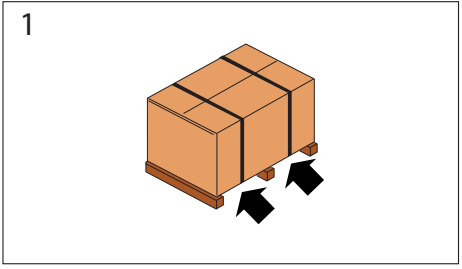
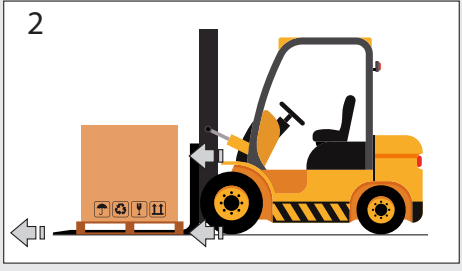

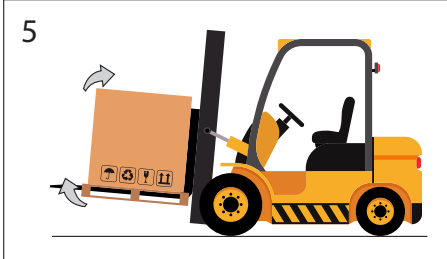

If cardboard boxes (single or multiple) are carried on a pallet, proceed as indicated in Tab. 6.25.:

Step	Action	Image
1	Place the forks of the forklift under the load surface.	
2	Make sure that the forks protrude from the front of the load (by at least 5 cm), far enough to eliminate any risk of the transported load tipping.	
3	Raise the forks until they are touching the load. <div style="border: 1px solid blue; padding: 5px; margin-top: 10px;"> <p>NOTICE! Fasten the load to the forks with clamps or similar devices if required.</p> </div>	
4	Slowly lift the load by a few dozen centimetres and check its stability, making sure that the centre of gravity of the load is at the centre of the lifting forks.	

Step	Action	Image
5	Tilt the mast backwards (towards the driver's seat) to help the over-turning moment and to ensure greater load stability during transport.	
6	Adjust transport speed according to the type of floor and load, avoiding sudden manoeuvres. ⚠ WARNING! In case of: <ul style="list-style-type: none"> • obstacles along the path; • particular operating situations; hinder operator visibility, the assistance of a ground operator is required, standing outside the range of action of the lifting equipment, with the task of signalling.	-
7	Place the load in the chosen installation area.	-

Tab. 6.25.

6.7 - PACKAGING REMOVAL

Packaging removal	
Operator qualification	<ul style="list-style-type: none"> Installer.
PPE required	<div style="display: flex; align-items: center;">     </div> <div style="background-color: #f4a460; padding: 5px; margin-top: 10px;"> <p>⚠ WARNING!</p> </div> <p>The PPE listed in this table is related to the risk associated with the equipment. For the PPE necessary to protect against risks associated with the workplace or operating conditions, please refer to:</p> <ul style="list-style-type: none"> the regulations in force in the country of installation; <u>any information provided by the Safety Manager at the installation facility.</u>

Tab. 6.26.

To unpack the cardboard boxes (single or multiple) supported by a pallet, proceed as described in Tab. 6.27.:

Step	Action
1	Remove the stretch film around the pallet.
2	Remove the 4 support corners.
3	Move the boxes of the equipment from the pallet to their intended place. <div style="border: 1px solid #0070c0; padding: 5px; margin-top: 10px;"> <p>! NOTICE!</p> <p>Have at least 2 operators manually move the packages if required due to their dimensions/weight.</p> </div>

Tab. 6.27.

! NOTICE!

After removing all packaging materials, check for any anomalies.

If there are anomalies:

- do not install the equipment;
- contact PIETRO FIORENTINI S.p.A. and specify the details provided on the equipment nameplate.

⚠ WARNING!

The single piece of equipment is contained in a specifically created cardboard box.

Avoid taking the equipment out of the box before its installation.

6.7.1 - PACKAGING DISPOSAL

! NOTICE!

Sort the various materials making up the packaging and dispose of them in compliance with the regulations in force in the country of installation.

7 - INSTALLATION

7.1 - GENERAL WARNINGS

 **WARNING!**

The installation must be performed by qualified personnel, in compliance with the provisions in force concerning safety.

 **WARNING!**

For the safe use of the equipment, respect the permitted environmental conditions and comply with the data shown on the nameplate.

 **WARNING!**

It is strictly forbidden to make any modifications to the equipment.

 **WARNING!**

PIETRO FIORENTINI S.p.A. is not liable for damage caused by incorrect installation of the equipment and/or otherwise different from that indicated in this manual.

7.2 - INSTALLATION PRE-REQUISITES

7.2.1 - ALLOWED ENVIRONMENTAL CONDITIONS

 **NOTICE!**

For details on the allowed environmental conditions (temperature range and classification) refer to paragraph 4.3 “Technical data”.

 **WARNING!**

PIETRO FIORENTINI S.p.A. is not liable for damage and/or malfunctions caused by installation in environments other than those permitted.

7.3 - CHECKS BEFORE INSTALLATION







RS must be connected to an installation.

The installation site must be suitable for the safe use of the equipment.

The equipment installation area must have lighting that guarantees the operator good visibility during the installation phases.

Before installation, it must be ensured that:

- the installation compartment meets the provisions in force on safety and is away from any possible damage of mechanical origin, away from sources of heat or naked flames, in a dry place and protected from external agents;
- the utilities on the customer side are closed;
- there are no impediments that could hinder the installer's installation operations;
- the upstream and downstream pipes are at the same level and can bear the weight of the equipment;
- there are no stresses on the connections;
- the inlet and outlet connections of the equipment are clean and have not been damaged;
- mechanical stresses on the inlet and outlet connections are totally absent.

Installation	
Operator qualification	<ul style="list-style-type: none"> • Installer.
PPE required	<div style="display: flex; align-items: center;">      </div> <div style="background-color: #f4a460; padding: 5px; margin-top: 5px;">  WARNING! </div> <p>The PPE listed in this table is related to the risk associated with the equipment. For the PPE required to protect against risks associated with the workplace, installation or operating conditions, please refer to:</p> <ul style="list-style-type: none"> • the regulations in force in the country of installation; • any information provided by the Safety Manager at the installation facility.
Equipment required	Keys to fix inlet and outlet connections fittings/equipment.

Tab. 7.28.

7.4 - SPECIFIC SAFETY INSTRUCTIONS FOR THE INSTALLATION STEP

NOTICE!

The equipment is delivered ready for use.

WARNING!

Before proceeding with installation, make sure that the upstream and downstream valves installed on the line are shut off.

WARNING!

Installation may also take place in areas where there is a risk of explosion, which implies that all necessary prevention and protection measures have to be taken.

For these measures, please refer to the regulations in force at the place of installation.

WARNING!

Near the equipment, do not:

- use open flames (e.g. for welding operations);
- smoke.

WARNING!

Before connecting, make sure that:

- at least the portion of the system upstream of the equipment has been cut off and that, therefore, no flow of gas occurs during installation;
- the maximum system pressure is lower than the maximum pressure set for the equipment, which is fixed and equal to 0.5 relative bar.

WARNING!

Install the equipment with the indicator device in a horizontal position, not in direct contact with the wall and raised from the floor.

WARNING!

During the equipment installation:

- avoid mechanical stresses on its inlet/outlet connections;
- implement protective measures against electrostatic discharges.

ATTENTION!

If piping has been subsequently installed on the meter for pressure measurement, check the tightness of the relevant connection.

7.5 - INSTALLATION PROCEDURE

! NOTICE!

RS operates only in an upright position.

Proceed as described in Tab.7.29 for the **installation of the meter (A)**:

Step	Action
1	Remove the 2 protection caps of the connection fittings (B), if still present.
	Place the meter in the adequately prepared compartment, in the section of the line used for it.
	<h3>! NOTICE!</h3> <p>The arrow on the top of the meter indicates the direction of the gas flow and therefore, the orientation of the meter within the relative compartment.</p>
2	Place the gaskets between the line fitting and the meter fitting.
	Connect the upstream and downstream pipes to the meter.
	<h3>! NOTICE!</h3> <ul style="list-style-type: none"> • Use suitable fittings (if necessary) for the connection. • Tighten the fittings in accordance with the tightening torques given in Table 7.30, using suitable hand tools (Ref. EN1359 for fittings DN 25 and DN 32). • In the case of single-pipe meters, there is only one pipeline.
3	
4	Slowly charge the meter RS with pressure and check the tightness of the connection fittings.
	<h3>! NOTICE!</h3> <p>The shut-off valve, located on the system upstream of the meter, must be opened gradually to avoid damage to the meter's internal components.</p>
5	The meter is now ready for use.
6	If present, slowly open the valve immediately downstream of the meter.

Tab. 7.29.

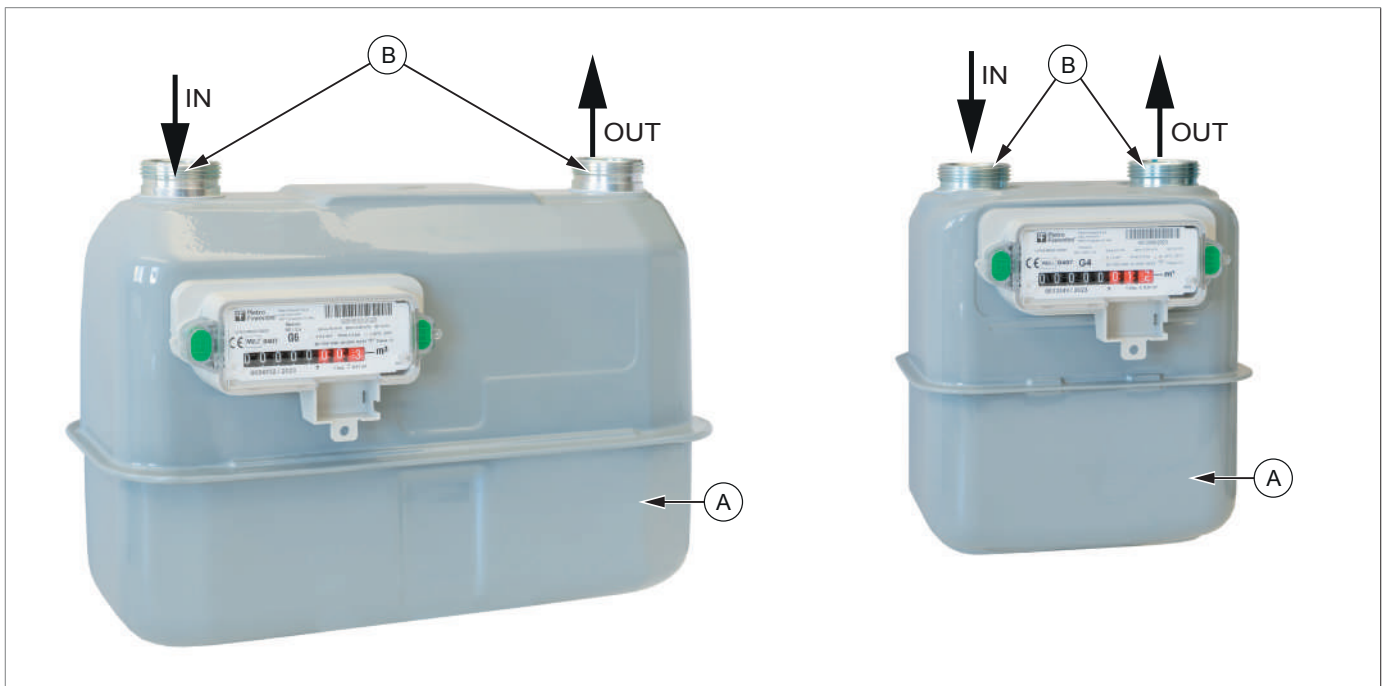

Fig. 7.7. Installation procedure

⚠ ATTENTION!

If piping has been subsequently installed on the meter for pressure measurement, check the tightness of the relevant connection.

7.6 - TIGHTENING TORQUES

	Monopipe	Double-pipe			
Connections DN threading	2" DN 25 according to DIN-3376-1	1" ¼ DN 32	1/2" DN 15	3/4" DN 20	7/8"
Distance between connections	-	110-130-160-250 mm	110-130-160 mm		
Tightening torque	170 Nm	110 Nm	50 Nm	80 Nm	

Tab. 7.30.

8 - MAINTENANCE AND FUNCTIONAL CHECKS

8.1 - GENERAL WARNINGS

HAZARD!

- Repair or maintenance work not provided for in this manual may be carried out only if approved by PIETRO FIORENTINI S.p.A.. PIETRO FIORENTINI S.p.A. shall not be held liable for damage to persons or property resulting from operations other than those described herein or carried out in ways other than as indicated.

HAZARD!

Special maintenance:

- requires extensive and specialised knowledge of the machines, operations required, risks involved and correct procedures to operate safely;
- must be provided by qualified, trained and authorised technicians.

WARNING!

In case of doubt, do not perform any work.

Contact PIETRO FIORENTINI S.p.A. for the necessary clarifications.

NOTICE!

Before starting maintenance on the equipment, it is advisable to make sure that the authorised operator has:

- the necessary equipment;
- appropriate spare parts.

The equipment RS does not require routine checks and maintenance procedures.

9 - UNINSTALLATION AND DISPOSAL

9.1 - GENERAL SAFETY WARNINGS

HAZARD!



Make sure that there are no potentially explosive ignition sources in the work area set up to uninstall and/or dispose of the equipment.

WARNING!

Before proceeding with uninstallation and disposal, make the equipment safe by disconnecting it from any power supply.

9.2 - QUALIFICATION OF THE OPERATORS IN CHARGE

Uninstallation

Operator qualification	<ul style="list-style-type: none"> Installer.
PPE required	<div style="display: flex; align-items: center;">  </div> <div style="background-color: #f96; padding: 5px; margin-top: 5px;">  WARNING! </div> <p>The PPE listed in this table is related to the risk associated with the equipment. For the PPE required to protect against risks associated with the workplace, installation or operating conditions, please refer to:</p> <ul style="list-style-type: none"> the regulations in force in the country of installation; any information provided by the Safety Manager at the installation facility.
Equipment required	Keys to fix inlet and outlet connections fittings/equipment.

Tab. 9.31.

9.3 - UNINSTALLATION

HAZARD!

The uninstalled meter may contain a residual amount of gas. To avoid the danger of explosion:

- thoroughly clean the meter with inert gas;
- use a vehicle with an open or ventilated loading area for transport (if necessary).

To properly uninstall the equipment, proceed as specified in Tab. 9.32.:

Step	Action
1	Close the valves upstream and downstream of the equipment.
2	Disconnect the upstream and downstream pipes from the equipment by unscrewing the fittings with adequate hand tools.
3	Remove the equipment. <div style="border: 1px solid blue; padding: 5px; margin-top: 5px;">  NOTICE! Seal the valves upstream and downstream of the equipment if: <ul style="list-style-type: none"> closing the system; the equipment is not replaced immediately. </div>

Tab. 9.32.

9.4 - INFORMATION REQUIRED IN CASE OF NEW INSTALLATION

NOTICE!

Should the equipment be reused after uninstallation, refer to chapters: “Installation” and “Configuration”.

9.5 - INFORMATION REQUIRED IN CASE OF RE-INSTALLATION

NOTICE!

Refer to chapter 7 “Installation” if the equipment is to be reused after uninstallation.

9.6 - DISPOSAL INFORMATION

NOTICE!

- Proper disposal prevents damage to humans and the environment and promotes the reuse of precious raw materials.
- Bear in mind that the regulations in force in the country of installation must be complied with.
- Illegal or improper disposal involves the application of the penalties provided for by the regulations in force in the country of installation.

The equipment was manufactured with materials that can be recycled by specialised companies. For proper disposal of the equipment, proceed as specified in Tab. 9.33.:

Step	Action
1	Set up a large work area free from obstacles where to safely dismantle the equipment.
2	Sort the various components by type of material for easier recycling through separate collection.
3	Send the materials obtained in Step 2 to a specialised company.

Tab. 9.33.

The equipment in any configuration consists of the materials described in Tab. 9.34.:

Material	Disposal/recycling indications
Plastic	It must be dismantled and disposed of separately.
Steel	Disassemble and collect separately. It must be recycled through the specific collection centres.
Stainless steel	Disassemble and collect separately. It must be recycled through the specific collection centres.
Aluminium	Disassemble and collect separately. It must be recycled through the specific collection centres.

Tab. 9.34.

NOTICE!

The above materials refer to standard versions. Different materials can be provided for specific needs.

TM0132EN

